

Current part is item (3) on diagram. Available at www.oshkoshequipment.com

(1) (a) FIG. NO.	(2) (b) ITEM NO.	(3) SMR CODE	(3) NATIONAL STOCK NUMBER	(4) PART NUMBER	(5) FSCM	(6) DESCRIPTION USABLE ON CODE	(7) U/M	(8) INC IN UNIT
0505-FAN ASSEMBLY								
53	1	PAOZZ	3030-00-294-9540	MS51067-54-2	96906	BELT,V,MATCHED SET: GENERATOR AND WATER PUMP AA	SE	1
53	2	PAOZZ	5306-00-225-8506	MS90725-42	96906	BOLT,MACHINE: FAN AA	EA	6
53	3	PAOZZ	5310-00-514-6674	MS35335-34	96906	WASHER,LOCK: FAN AA	EA	6
53	4	PAOZZ	2930-00-706-1323	7061323	19207	FAN,ENGINE COOLING: WATER PUMP AA	EA	1
53	5	PAOZZ	2930-00-752-1873	7521873	19207	ADAPTER: WATER PUMP PULLEY AA	EA	1
53A	1	PAOZZ	5306-00-225-8500	MS90725-35	96906	BOLT,MACHINE: ENGING FAN TO WATER PUMP PULLEY AB,AC	EA	4
53A	2	PAOZZ	5310-00-959-4679	MS35340-45	96906	WASHER,LOCK AB,AC	EA	2
53A	3	PAOZZ	2930-00-113-0768	11641747	19207	IMPELLER,FAN,AXIAL: ENGINE COOLING AB,AC	EA	1
53A	4	PAOZZ	3030-00-863-7738	5702650	19207	BELTS,V,MATCHED SET: WATER PUMP AND GENERATOR DRIVE AB,AC	EA	1



Current part is item (3) on diagram. Available at www.oshkoshequipment.com

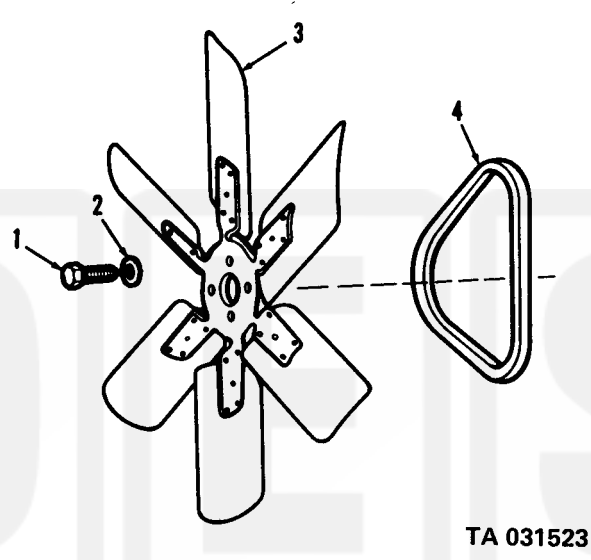

Figure 53A. Engine cooling fan and belt.

Oshkosh
Equipment Sales